

Bathroom Vanity #J040222 Installation

INSTALLATION MANUAL Tools You Will Need:

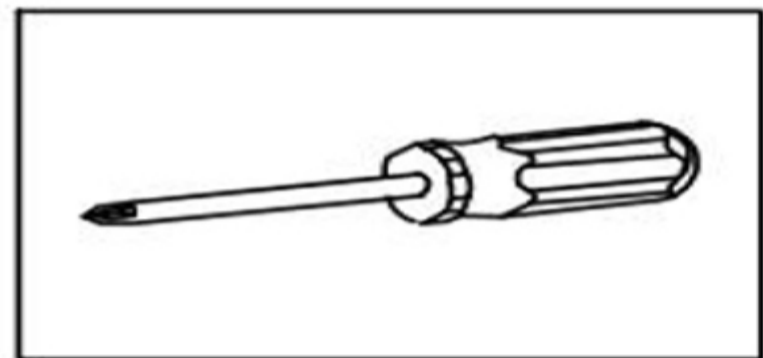
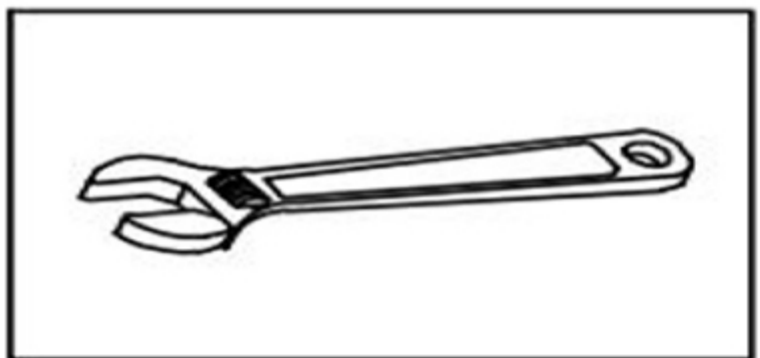

Adjustable Wrench

Philips Screwdriver

Before the Installation

1. Do not throw away packing materials until assembly is complete for small parts may come loose inside the carton during shipment. If parts are missing, please contact us.
2. Assemble this item on a soft surface, such as carpet to protect the finish.
3. Periodically check to ensure that all connections are tight.
4. It is recommended that installation of the product be done by a qualified licensed plumber.

parts

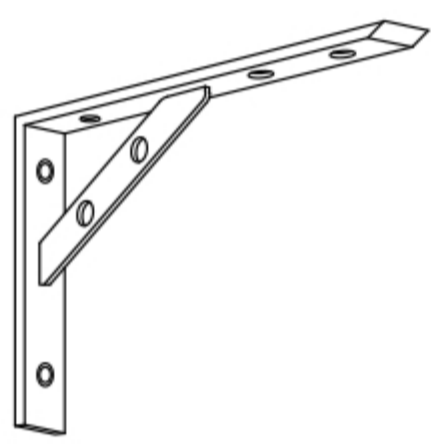

Ax2

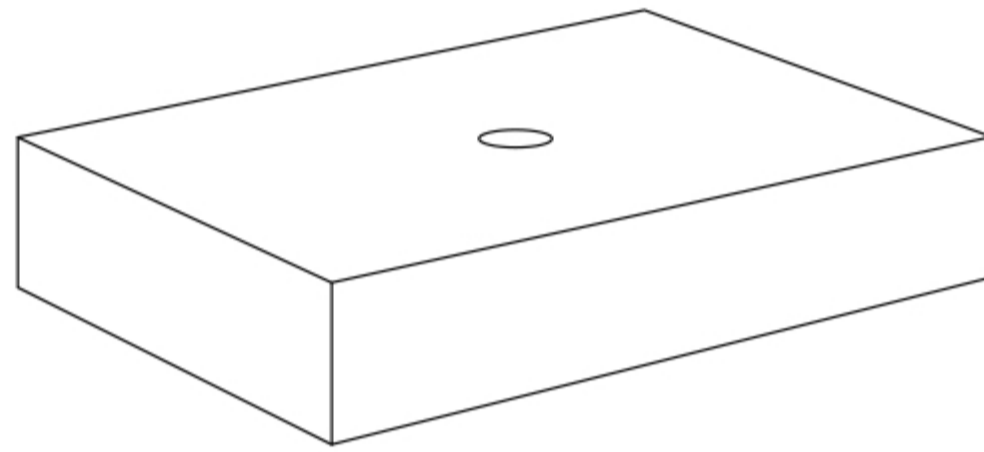

Bx1

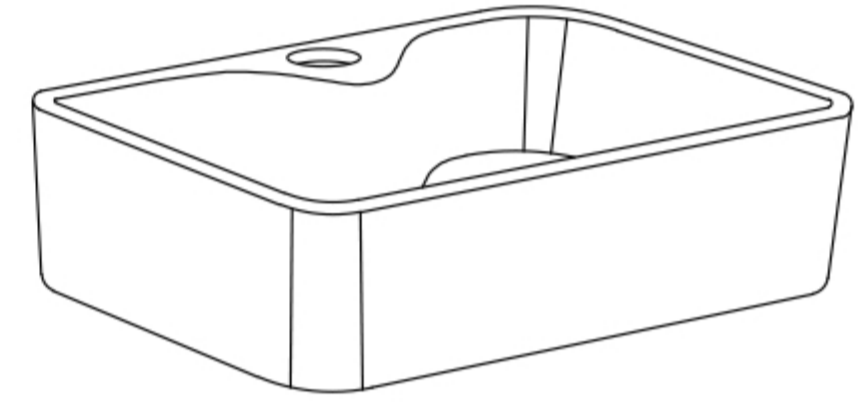

Ex1

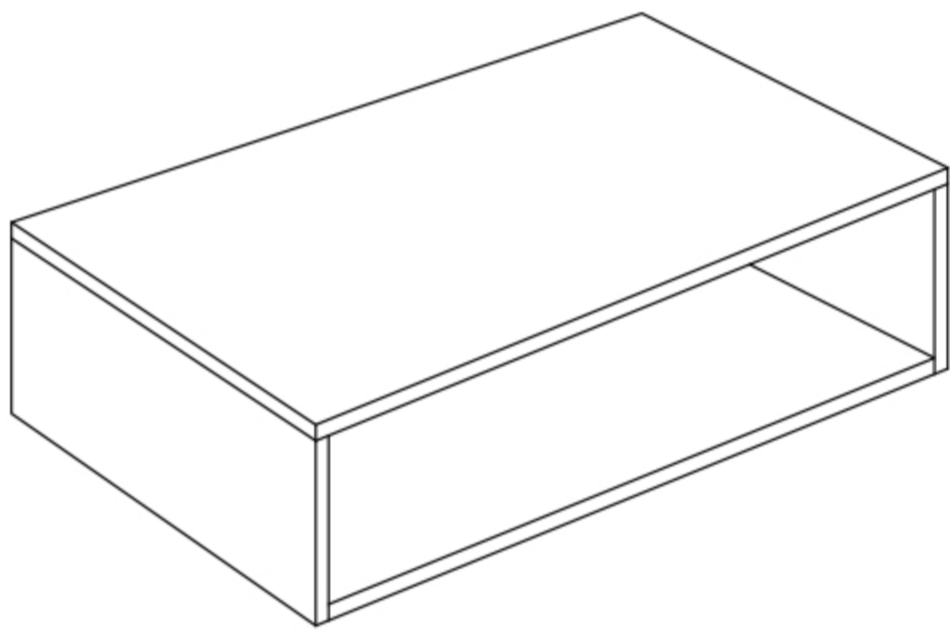

Dx1

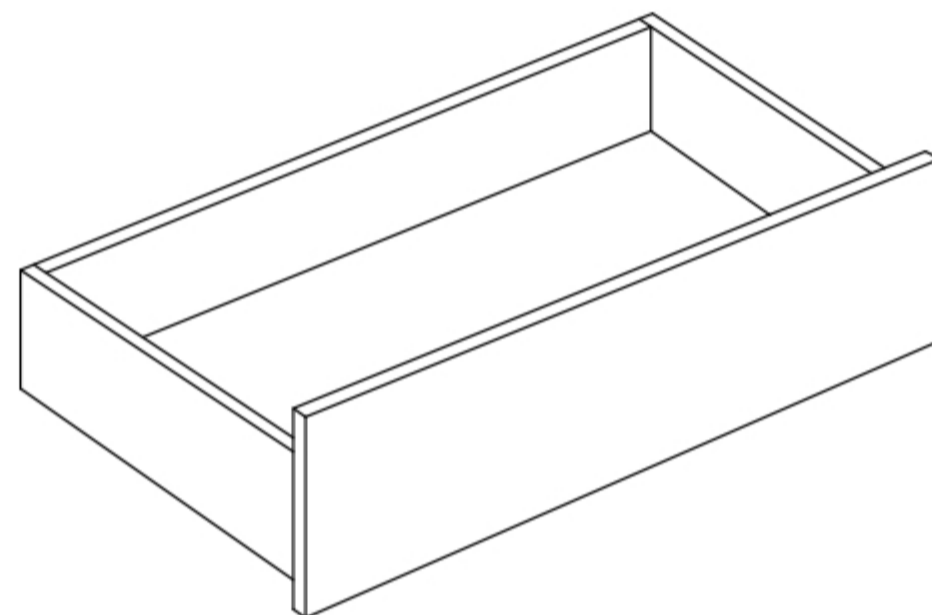

Cx1



Fx2

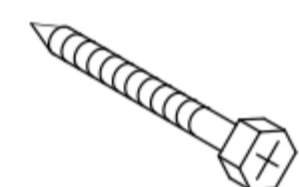

Gx6

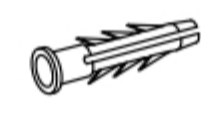

Hx8



Ix4

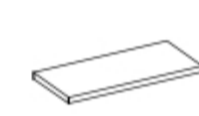

Jx8

Installation Guide

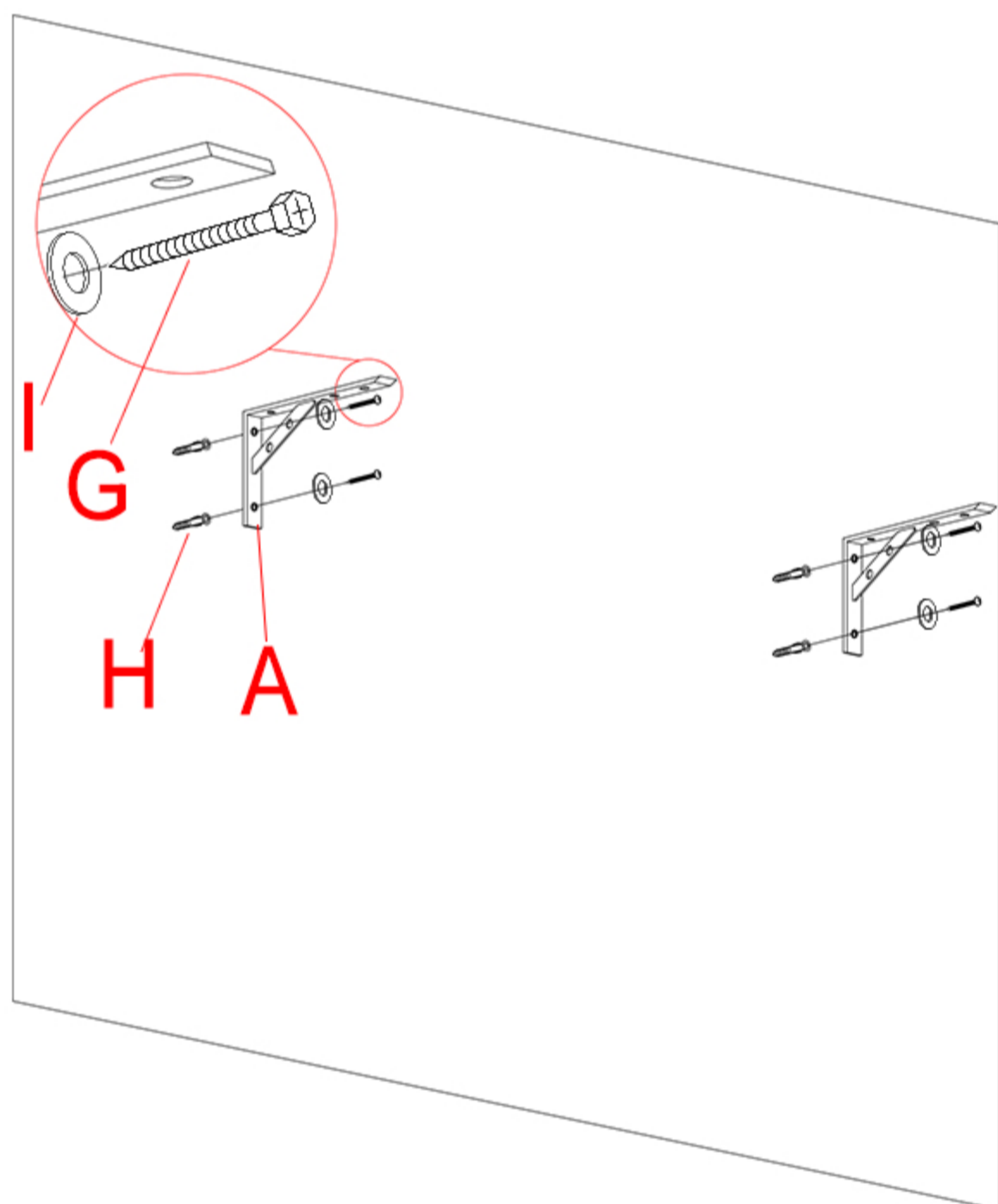

1. Determine the vanity placement and mark holes on the wall. Then install the expansion screws in wall. Fix the mounting brackets (A) with screws. (Note: Use a level to ensure that the brackets (A) is straight and level.)

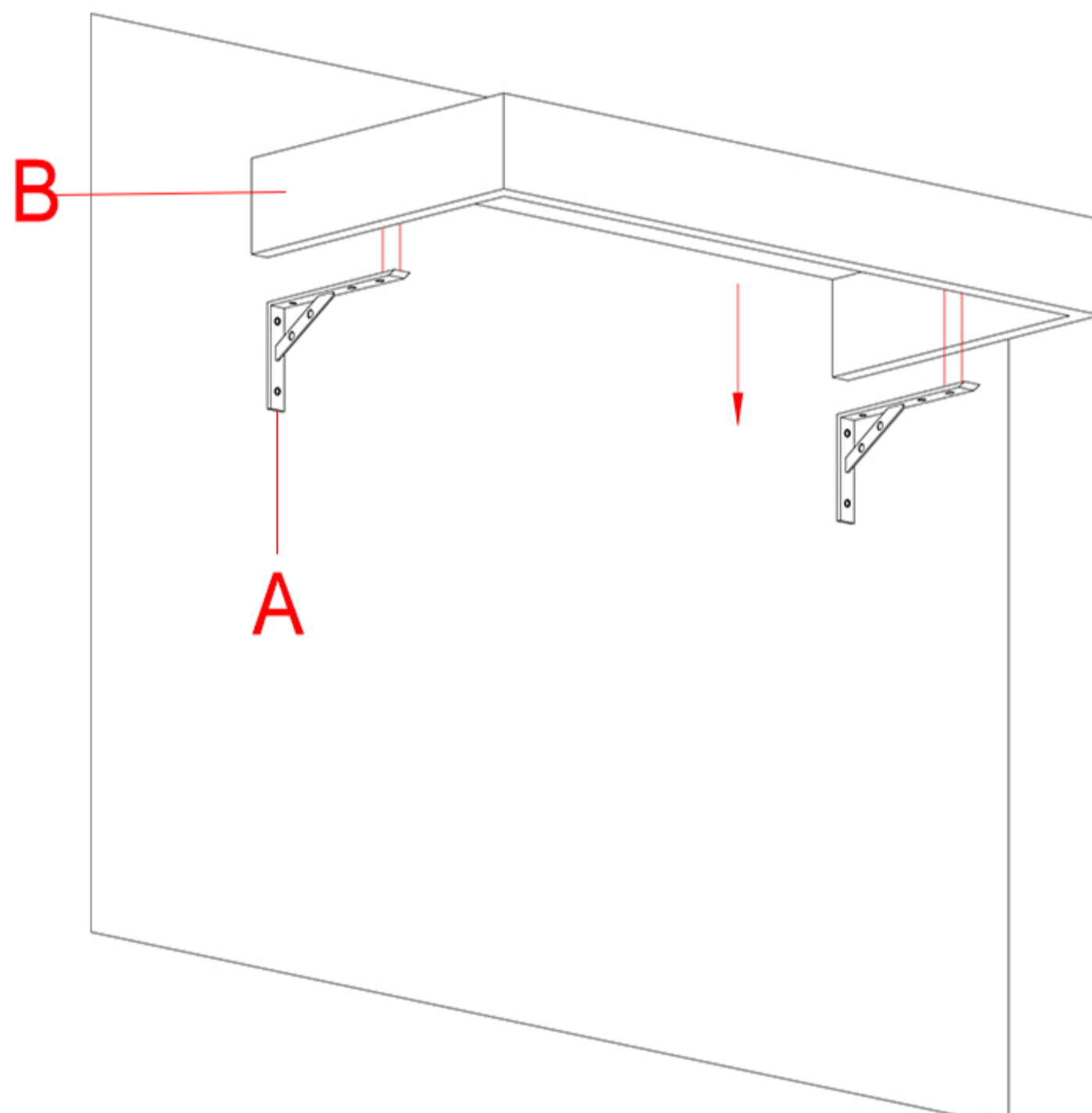

2. Place the countertop (B) onto the mounting brackets (A). Apply silicon sealant to the mounting surface and press firmly.

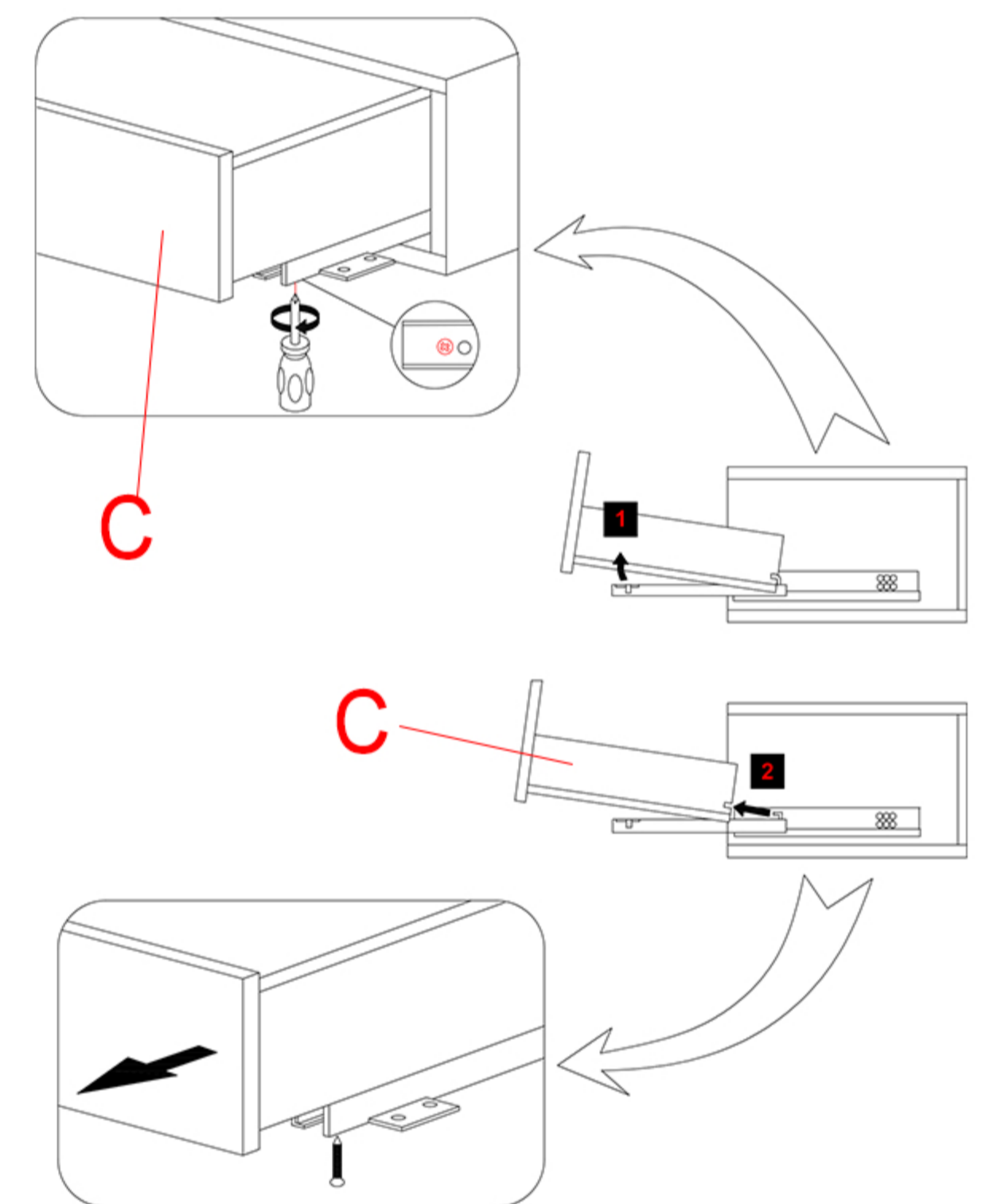

3. Unscrew the screw and remove the drawer (C).

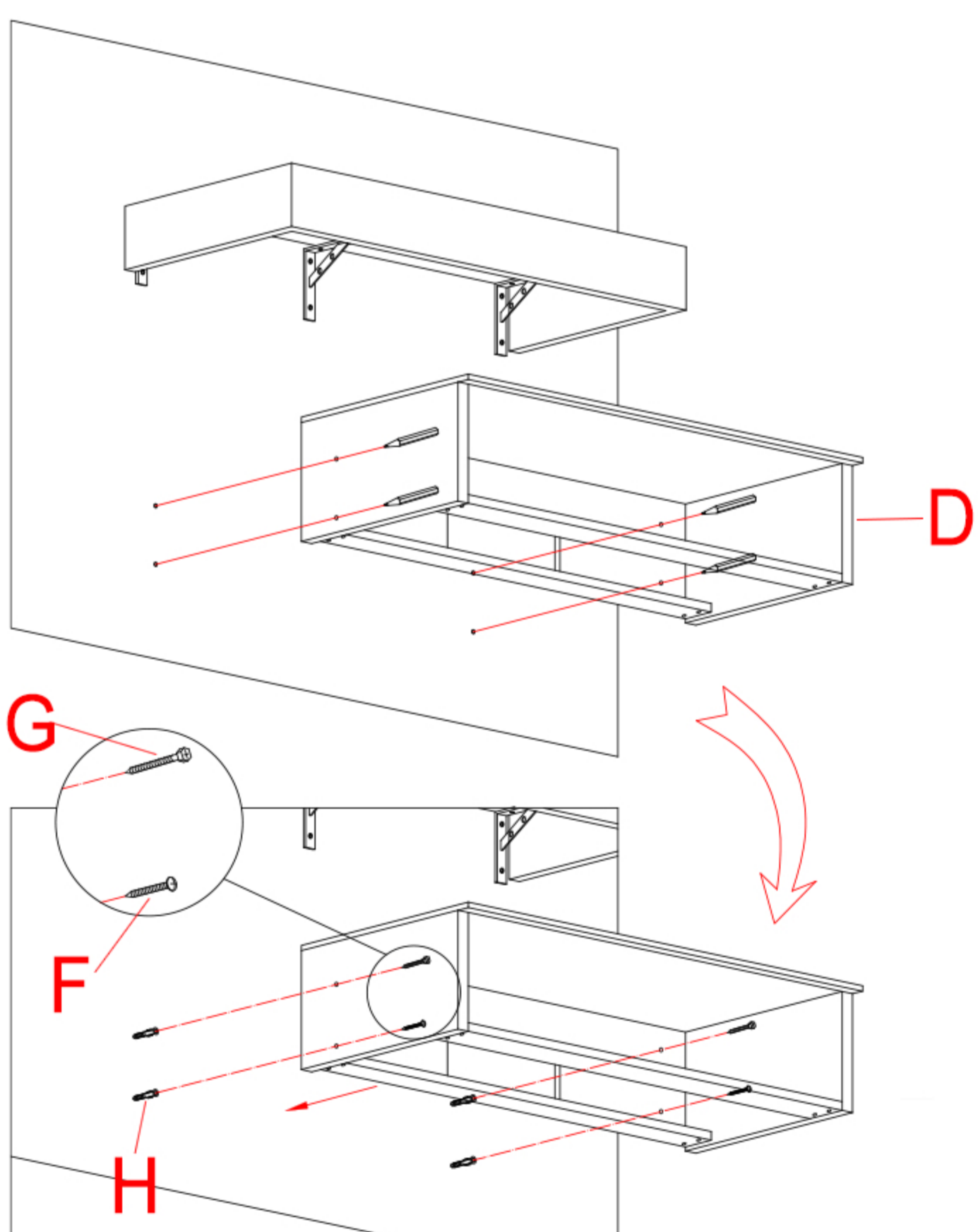

4. Mark holes on wall and drill holes. Install vanity (D) to the wall with screws.

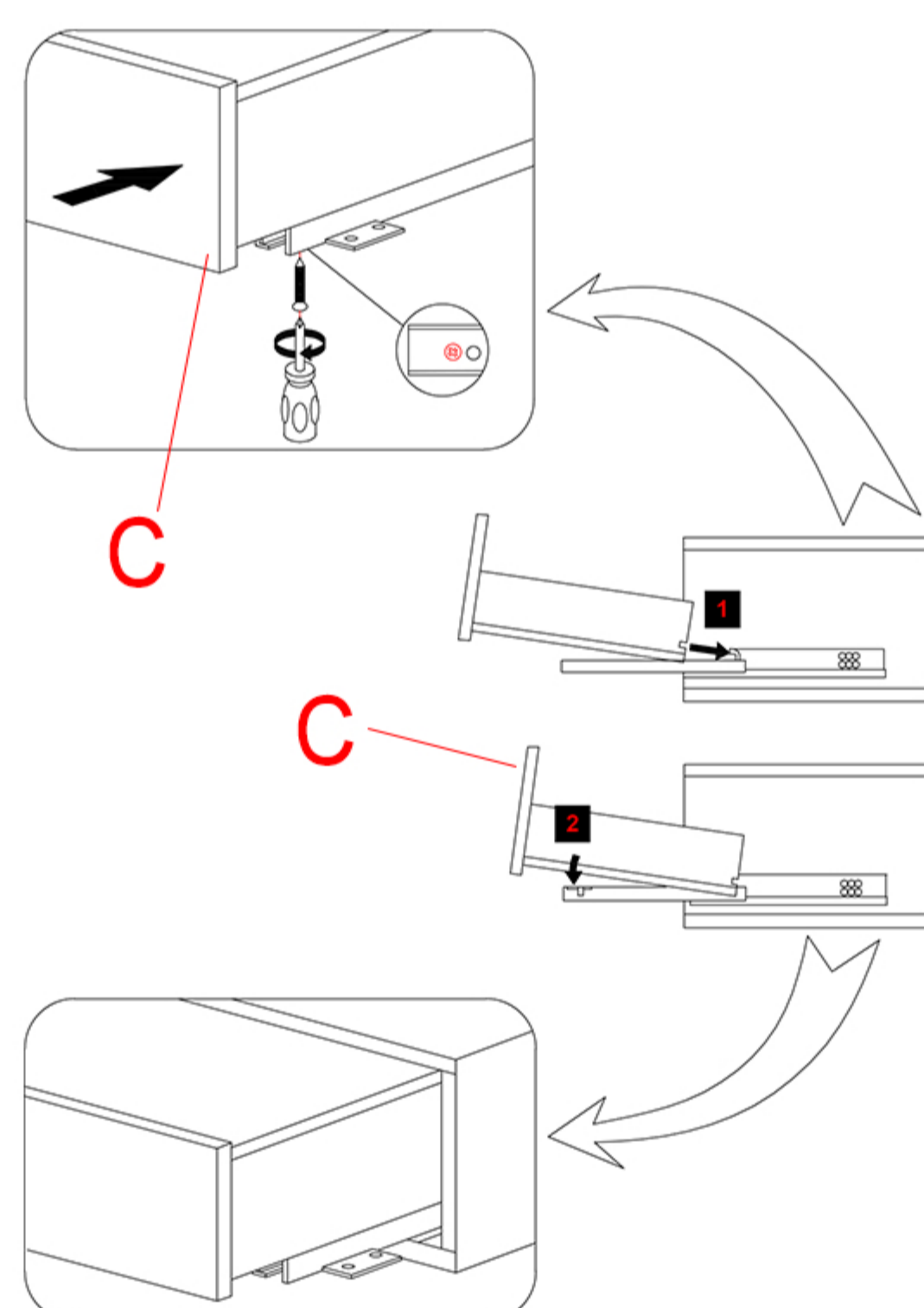

5. Install back the drawer (C).

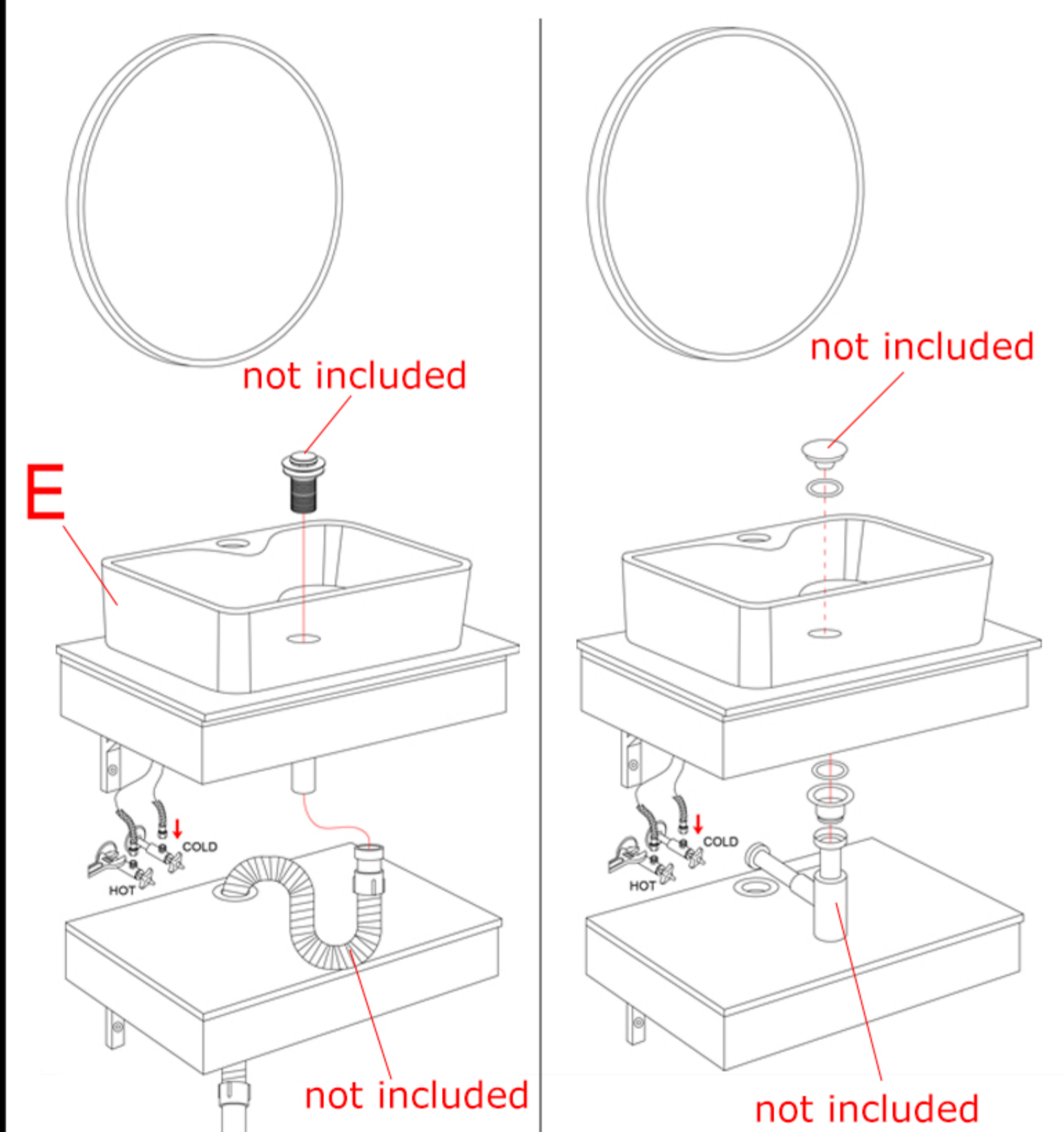

6. Install the vessel sink (E). Install drain (not included) and p-trap or drain hose (not included) as above.