

Tub Installation

Tools You Will Need:

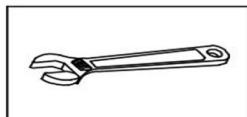

Adjustable wrench

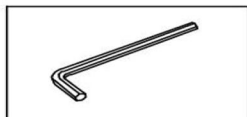

Hexagon wrench

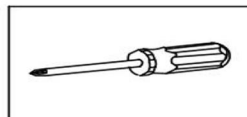

Phillips Screwdriver

Before the Installation

1. Do not throw away packing materials until assembly is complete for small parts may come loose inside the carton during shipment. If parts are missing, please contact us.
2. Assemble this item on a soft surface, such as carpet to protect the finish.
3. Proper assembly of this item requires 2 people.
4. Periodically check to ensure that all connections are tight.
5. It is recommended that installation of the product be done by a qualified licensed plumber.

Care and Cleaning

1. To protect the finish, avoid use chemicals and household cleaners.
2. All hot serving dishes should be placed on a pad.
3. Any liquid spilled onto the top should be cleaned up immediately with a damp cloth.

Parts List

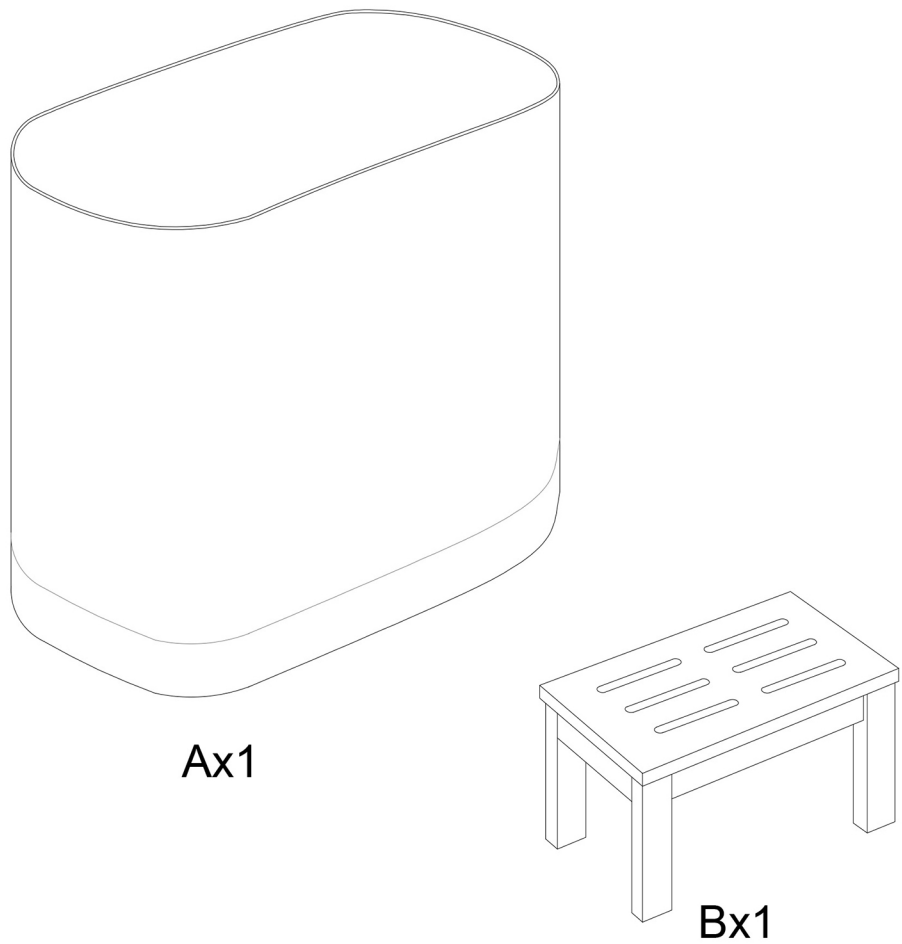
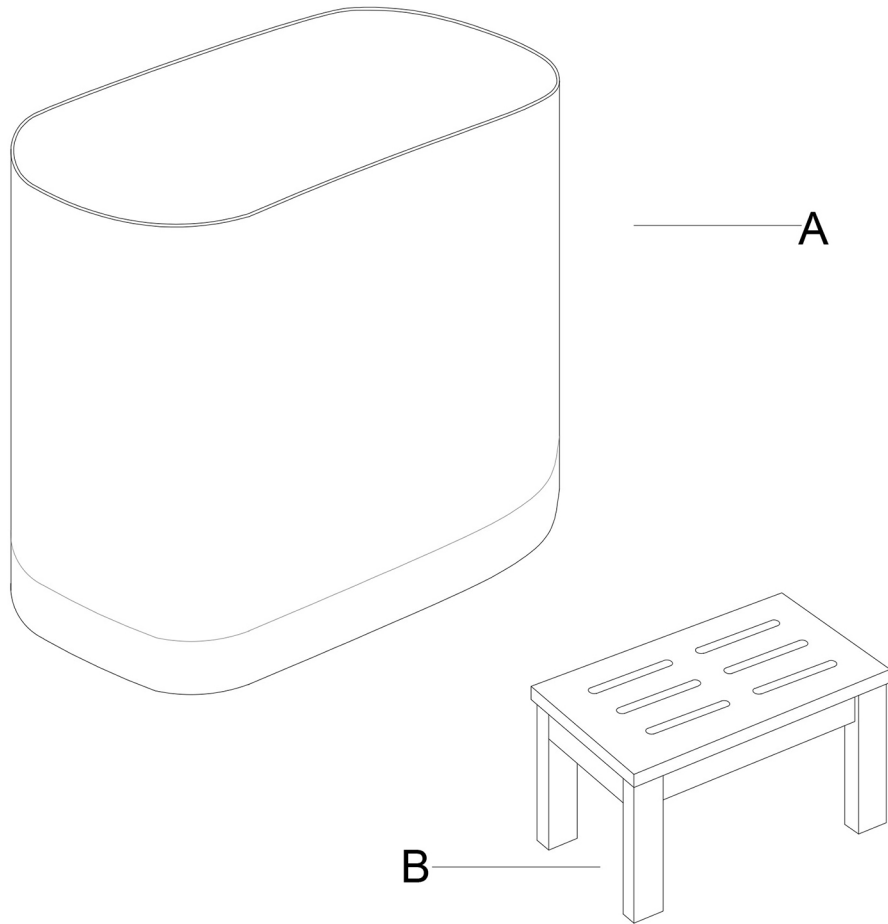

Instructions for water and electricity installation drawings

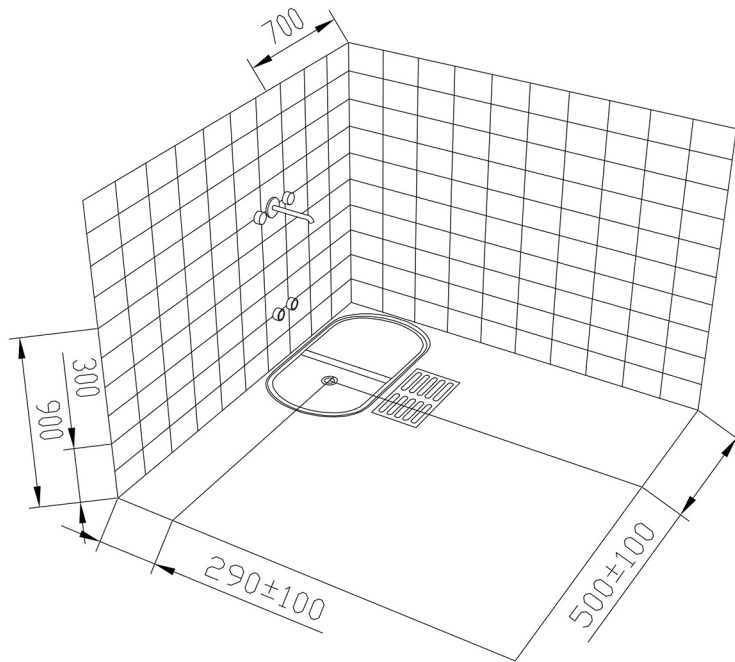

size: 1100*580*750mm

Step 2

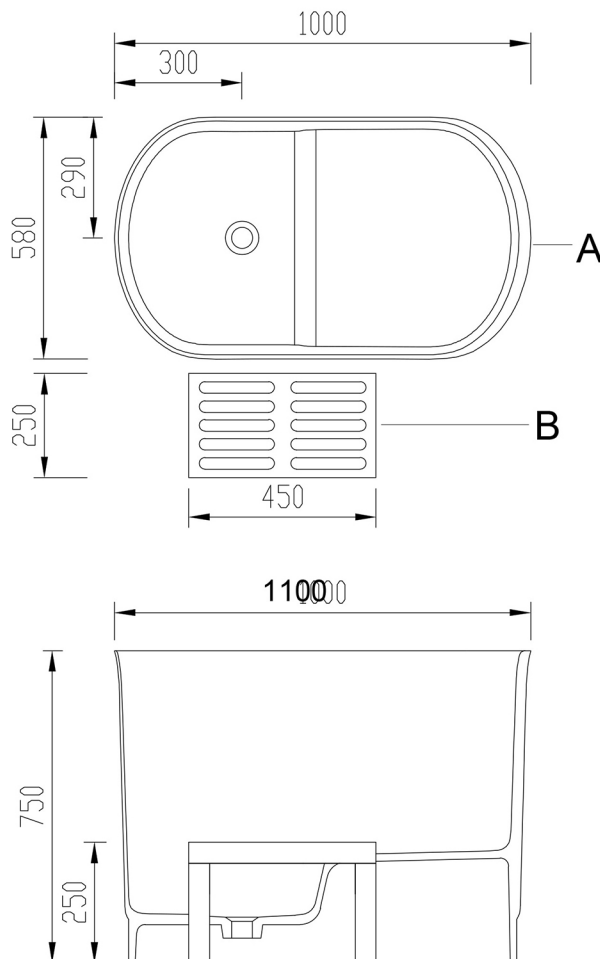

Installation instructions:

1. Water source: hot and cold galvanized pipes are connected to the floor faucet through one underground prefabricated groove. The floor faucet is about 50MM away from the cylinder edge and 300mm above the ground. Cut-off valves are installed outside the wall.
 2. Drainage: The position of the drain outlet in the drawing is for reference only, and the central independence depends on the actual situation, and the distance should be. No more than 200mm away from the bathtub drain and connected with a hose.
- 31°C